



XOT48KSE
WALL MOUNT HOOD

HOW BEAUTIFUL KITCHENS BREATHE



XOT48KSE

- 3 Speed Electronic Control
- Powerful, Precision Balanced Blower
- High Efficiency 3000K LED Lights
- 5 Minute delay function

POWERFUL 1000CFM - DESIGNED AND CRAFTED IN ITALY

The XOTK exemplifies the classic American Pro Hood design. This high performance under cabinet hood includes baffle filters. Our superior quality materials and workmanship make this hood a standout among the rest.

WORLD CLASS SERVICE | COMPREHENSIVE WARRANTIES
OUR LASTING COMMITMENT TO YOU



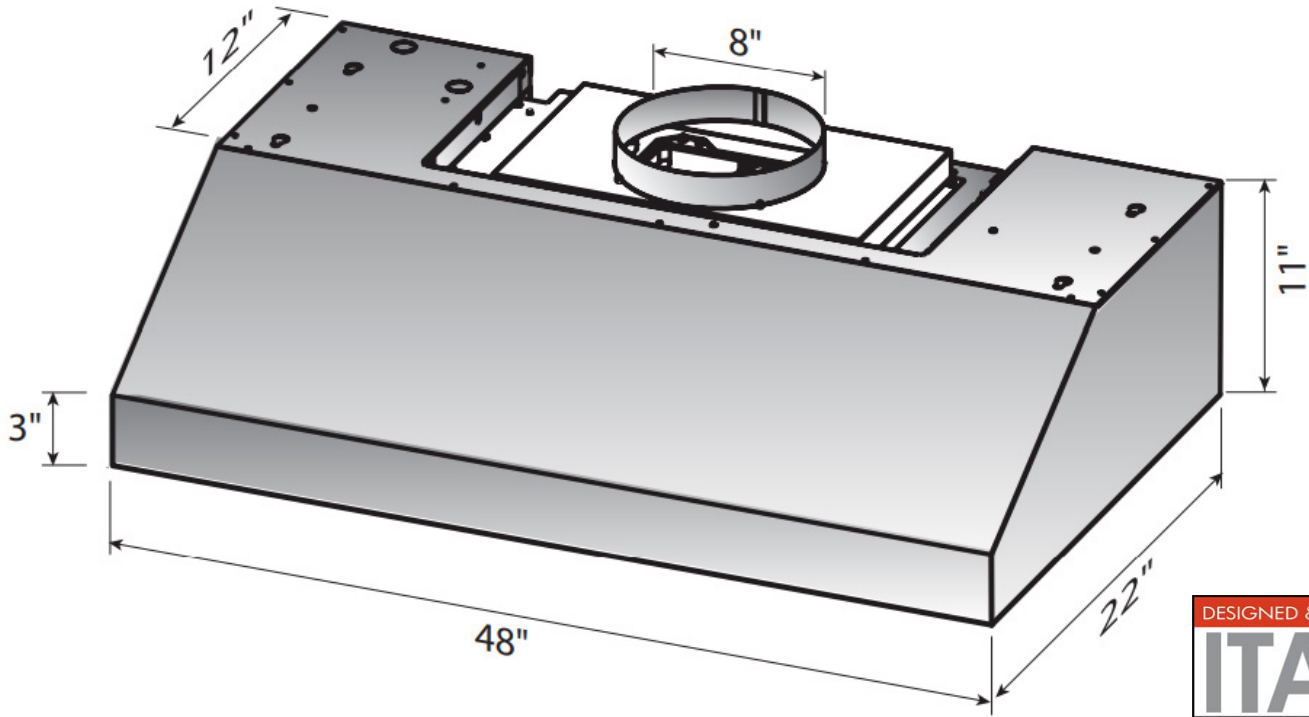

FEATURES

FINISH

Stainless Steel

FEATURES

- 3 Speed Electronic Control
- High Efficiency 3000k LED Lights (x2)
- Powerful, Precision Balanced Blower
- Dishwasher Safe Stainless Steel PRO Baffle Filters
- 5 Minute Delay Shutoff Timer
- 8" Vertical Ducting
- Made In Italy

PERFORMANCE

SPEED	1	2	3
CFM	200	590	1000
SONES	2.0	6.4	8.0

SPECIFICATIONS

ELECTRICAL 115VAC 60HZ 4.0 AMP

DIMENSIONS H 11" - 13 1/4" (Recirc)
W 48"
D 22"

MOUNTING HEIGHT

ABOVE COOKING 27" - 32"

OPTIONS

Recirculation Kit XOT48 **XORFK09**
 Recirculation Filters **XORFRND**
 ADA Compatible Remote **XOVREMOTE1**
 Make Up Air Kit (8") **XOMA08**

RECOMMENDED MOUNTING HEIGHT

All range hoods have a recommended range of installation height over the cooking surface. However cooking styles, types of cooking equipment and installation limitation can vary greatly. For installations outside the recommended range - consult XO.

THESE MODELS HAVE A 8" DIAMETER EXHAUST DUCT WHICH MAY BE CONFIGURED FOR TOP DUCTING ONLY. CONSULT MANUAL FOR ADDITIONAL INFORMATION.

MAKE-UP AIR

Many states have adopted regulations regarding the re-introduction of make-up air for homes with ventilation systems which can exhaust more than a specified volume of air, typically 400 CFM.

Your cooking equipment and use determine how much ventilation you need. If your local building codes require a make-up air solution based on that need, XO has the answer.

XOMA MAKE-UP AIR KITS

Make-Up Air Kits consist of two parts.

1. A sensor collar which is mounted in the exhaust duct of the hood. This contains a feather switch that is activated when air flow is detected in the duct.

2. A motorized air inlet damper which is usually mounted to the home's HVAC system.

When it receives a signal from the sensor collar, the damper automatically opens to admit fresh air which is distributed via the HVAC system.

When the blower shuts off, the feather switch returns to the off position and the motorized damper is deactivated. The air inlet damper is automatically closed by a return spring.

